

# User Manual

Rechargeable Li-ion Battery System

Model: CIESS series

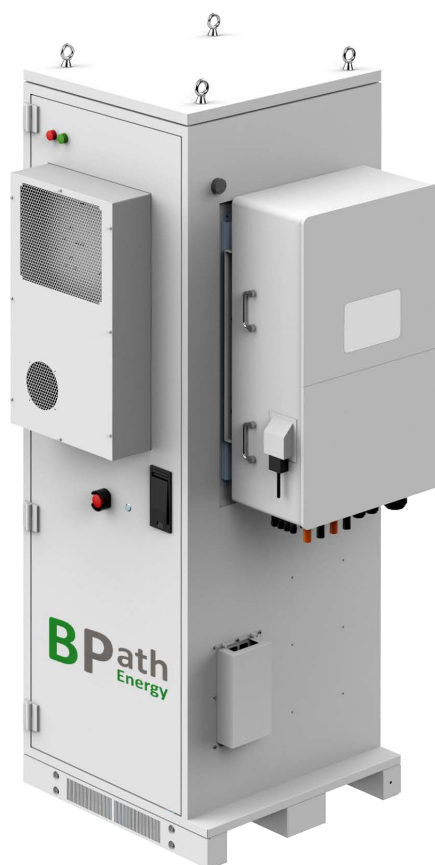

Version No. A02    Release Date: 2023-09-08

Sunwoda Energy Technology Co.,Ltd.



## Content

1	Safety instruction	1
1.1	Safety precaution.	1
1.1.1	Personal safety	1
1.1.2	Electrical safety	2
1.1.3	Environmental safety	2
1.1.4	Mechanical safety.	3
1.1.5	Battery safety	3
1.2	Symbols interpretation	4
2	System Introduction	5
2.1	System introduction	5
2.2	Structural composition	5
2.2.1	System Introduction	6
2.2.2	Battery modules Introduction.	8
2.2.3	Main control module introduction	8
2.2.4	Nameplates Introduction	9
3	System Installation	10
3.1	Installation precautions	10
3.2	Pre installation inspection	11
3.3	Installation.	13
3.3.1	Installation preparation.	13
3.3.2	Installation guidance	13
3.4	Cable connection.	15
3.4.1	Grounding	16
3.4.2	AC cable connection	17
3.4.3	DC cable connection	19
3.4.4	Communication connection	20
4	Operating Instructions.	20
4.1	Inspection before power on.	20
4.2	System startup	21
4.3	Indicator lights introduction	22
4.4	System monitoring settings	23
4.5	System Shutdown	30
5	Maintenance and Common Fault Handling	32
5.1	Daily maintenance.	32
5.2	Battery Fault Handling	32
6	Transportation and Storage	34
6.1	Transportation requirements	34
6.2	Storage requirements.	35
	Appendix: Technical Specification Parameter Table.	37

# 1 Safety instruction

Before transportation, storage, installation, operation, use, or maintenance of equipment, please carefully read and properly store this manual and strictly follow the safety precautions required by the manual content for operation. The safety precautions mentioned in this manual are only a supplement to local safety regulations.

The "danger", "warning", "caution", and "instructions" in the manual do not represent all safety precautions that should be followed. You are also required to comply with relevant international, national, or regional standards, as well as industry practices. Our company does not assume any responsibility for violating safety operation requirements or violating safety standards for the design, production, and use of equipment.

The equipment shall be used in an environment that meets the requirements of the design specification; otherwise, equipment failure, equipment function abnormality, or component damage may be caused, which is not within the scope of equipment quality assurance. Otherwise, our company shall not be liable for compensation for potential personal injury, property damage, etc.

All operations, such as transportation, storage, installation, operation, use, and maintenance, should comply with applicable laws, regulations, standards, and normative requirements. It is not allowed to study the internal implementation logic of the device in any way, obtain the source code of the device software, infringe intellectual property rights, or to disclose the results of any device software performance testing.

Our company shall not be liable for any of the following situations or their consequences:

- Equipment damage caused by earthquake, flood, volcanic eruption, debris flow, lightning strike, fire, war, armed conflict, typhoon, hurricane, tornado, extreme weather, force majeure,
- Not operating within the usage conditions specified in this manual,
- The installation and usage environment do not comply with relevant international, national, or regional standards,
- Failure to follow the operating instructions and safety warnings in the product and documentation;
- Unauthorized disassembly, modification of products, or modification of software codes;
- The materials and tools you provide do not meet the requirements of local laws, regulations, and relevant standards.
- Damage caused by negligence, intent, gross negligence, improper operation, or non-company reasons by you or a third party.



## 1.1 Safety precaution

### 1.1.1 Personal safety



 <b>Dangerous</b>
<ul style="list-style-type: none"> <li>● Live operation is strictly prohibited during the installation process. It is prohibited to install or remove cables with electricity. When the cable core comes into contact with the conductor, it may generate electric arcs, sparks, or explosions, which can lead to fire or personal injury.</li> </ul>
<ul style="list-style-type: none"> <li>● When the equipment is electrified, the non-standard and incorrect operation may cause fire, electric shock, or explosion, leading to personal injury or property damage.</li> </ul>

<ul style="list-style-type: none"> <li>● It is strictly prohibited to wear easily conductive objects such as watches, bracelets, bangles, rings, necklaces, etc. during the operation to avoid being burned by electric shock.</li> </ul>
<ul style="list-style-type: none"> <li>● During operation, special insulation tools must be used to avoid electric shock injuries or short circuit faults. The insulation's ability to withstand voltage levels must meet the requirements of local laws, regulations, standards, and specifications.</li> </ul>
 <b>Warning</b>
<ul style="list-style-type: none"> <li>● Special protective equipment must be used during the operation process, such as wearing protective clothing, insulated shoes, goggles, safety helmets, insulated gloves, etc.</li> </ul>

### 1.1.2 Electrical safety



 <b>Dangerous</b>
<ul style="list-style-type: none"> <li>● Before making electrical connections, please ensure that the equipment is not damaged; otherwise, it may cause an electric shock or fire.</li> </ul>
<ul style="list-style-type: none"> <li>● Unstandardized and incorrect operations may cause accidents such as fires or electric shocks.</li> </ul>
<ul style="list-style-type: none"> <li>● During the operation, it is necessary to prevent foreign objects from entering the interior of the equipment; otherwise, it may cause short circuit faults or damage to the equipment, load power reduction or power loss, and personal injury.</li> </ul>
 <b>Warning</b>
<ul style="list-style-type: none"> <li>● When installing equipment that needs to be grounded, a protective ground wire must be installed first; When dismantling equipment, the protective ground wire must be removed last.</li> </ul>

### 1.1.3 Environmental safety

 <b>Dangerous</b>
<ul style="list-style-type: none"> <li>● It is strictly prohibited to place the equipment in a flammable, explosive gas, or smoke environment, and any operation is prohibited in this environment.</li> </ul>
<ul style="list-style-type: none"> <li>● It is strictly prohibited to store flammable and explosive materials in the equipment area.</li> </ul>
<ul style="list-style-type: none"> <li>● It is strictly prohibited to place the equipment near a heat source or fire source, such as smoke, fire, a candle, a space heater, or other heating equipment. Heating of the equipment may cause equipment damage or fire.</li> </ul>
<ul style="list-style-type: none"> <li>● During operation, special insulation tools must be used to avoid electric shock injuries or short circuit faults. The insulation's ability to withstand voltage levels must meet the requirements of local laws, regulations, standards, and specifications.</li> </ul>
 <b>Warning</b>
<ul style="list-style-type: none"> <li>● The equipment should be installed in an area far away from liquids, and it is strictly prohibited to install it below water pipes, air vents, and other locations that are prone to condensation; It is also strictly prohibited to install it below the air conditioning outlet, ventilation outlet, machine room outlet window, and other locations that are prone to water</li> </ul>

leakage, to prevent liquid from entering the equipment and causing equipment malfunction or short circuit.
<ul style="list-style-type: none"> <li>● When the equipment is running, do not block the ventilation openings, heat dissipation systems, or use other items to cover it to prevent high temperature damage to the equipment or ignition.</li> </ul>

#### 1.1.4 Mechanical safety

 <b>Dangerous</b>
<ul style="list-style-type: none"> <li>● High-altitude operations must wear safety helmets, safety belts, or waist ropes tied to sturdy structural components. It is strictly prohibited to hang on moving unstable objects or metal with sharp edges to prevent hook slipping and falling accidents.</li> </ul>
 <b>Warning</b>
<ul style="list-style-type: none"> <li>● The tools must be fully prepared and inspected by a professional organization to be qualified. It is prohibited to use tools that have scars, fail the inspection, or exceed the inspection validity period, to ensure that the tools are firm and not overloaded.</li> <li>● Before installing the equipment into the cabinet, first make sure that the cabinet is fixed to avoid tilting and collapsing due to an unstable center of gravity, which may cause injuries to installation personnel and equipment damage.</li> <li>● When pulling equipment out of the cabinet, be careful to install equipment that may be unstable or heavy inside the cabinet to avoid being crushed or crushed.</li> <li>● It is strictly prohibited to drill holes in the equipment. Drilling holes can damage the sealing, electromagnetic shielding performance, internal components, and cables of the equipment, and the metal chips generated by drilling holes entering the equipment can cause circuit board short circuits.</li> </ul>

#### 1.1.5 Battery safety













 <b>Dangerous</b>
<ul style="list-style-type: none"> <li>● It is strictly prohibited to short-circuit the positive and negative terminals of the battery; otherwise, it may cause a short circuit in the battery. The short circuit of the battery will generate a large current and release a large amount of energy in an instant, causing the battery to leak liquid, smoke, release combustible gas, thermal runaway, fire, or explosion. To avoid short circuits in the battery, live maintenance is not allowed.</li> <li>● Do not expose the battery to high-temperature environments or around heating equipment, such as high-temperature sunlight, a fire source, a transformer, a space heater, etc. Overheating of the battery may cause leakage, smoke, the release of combustible gas, thermal runaway, fire, or explosion.</li> <li>● It is strictly prohibited for the battery to be subjected to mechanical vibrations, falls, collisions, hard objects piercing, and pressure impacts; otherwise, it may cause battery damage or fire.</li> </ul>

- It is strictly prohibited to disassemble, modify, or damage the battery (such as by inserting foreign objects, squeezing by external force, immersion in water or other liquids), so as to avoid liquid leakage, smoke, release of combustible gas, thermal runaway, fire, or explosion of the battery.
- It is strictly prohibited for battery terminals to come into contact with other metal objects, as it may cause heating or electrolyte leakage.

 **Warning**

- When installing and testing batteries, fire protection facilities such as fire sand and carbon dioxide fire extinguishers must be equipped in accordance with construction standards and specifications. Before putting into operation, it is necessary to ensure that fire-fighting facilities that comply with local laws, regulations, and regulatory requirements are in place.
- The battery should be installed in an area far away from liquids, and it is strictly prohibited to install it below areas prone to water leakage such as air conditioning outlets, ventilation vents, machine room outlet windows, and water pipes, to prevent liquid from entering the equipment and causing equipment malfunction or short circuit.
- After the battery is discharged, it should be charged in a timely manner; otherwise, it may cause damage to the battery due to over-discharge.

## 1.2 Symbols interpretation

	Attention! Due to the danger caused by not following the requirements, it may lead to moderate or minor personal injury, as well as product damage!		This device cannot be discarded together with other household waste and must be sent to an appropriate institution for recycling and recycling!
	Danger: High voltage danger! Be careful of electric shock!		Recyclable!
	No Smoking or Fireworks!		Do not tilt or invert this face upwards!
	No stepping!		Please read the manual carefully before use!
	High temperature at the equipment air outlet, be careful when touching!		Protective grounding!
	Wait for 5 minutes after power outage to ensure complete discharge of the machine!		Grounding general identification!

## 2 System Introduction

### 2.1 System introduction

The CIESS series small integrated outdoor energy storage system adopts a modular design, which is easy to integrate, deploy, and expand, ensuring user system security. It can be used for various application scenarios such as peak shaving and valley filling, spontaneous self-use, demand management, off-grid backup, and optical storage and charging.

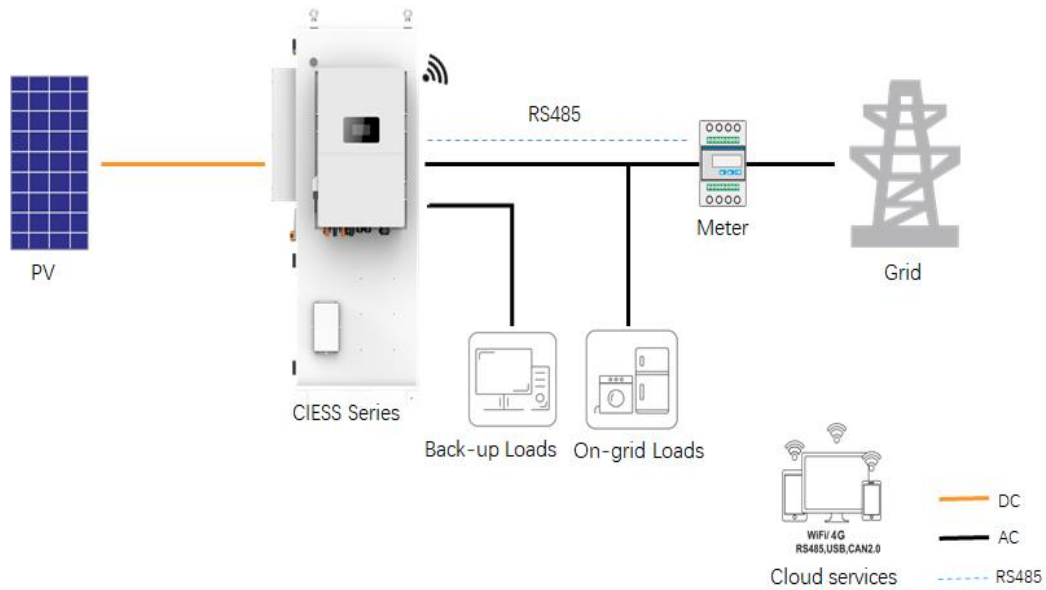

Figure 2-1 Typical Application Scenarios

This document mainly introduces the product introduction, installation, setup, maintenance, and technical parameters of the CIESS series small industrial and commercial energy storage battery system. The energy storage battery system mainly consists of a battery module, a main control module, a battery cabinet, and an energy storage inverter (optional).

### 2.2 Structural composition

The CIESS energy storage system adopts a modular design framework, which installs battery modules, main control modules, distribution components, and energy storage inverters (optional) as components for easy replacement.



## 2.2.1 System Introduction

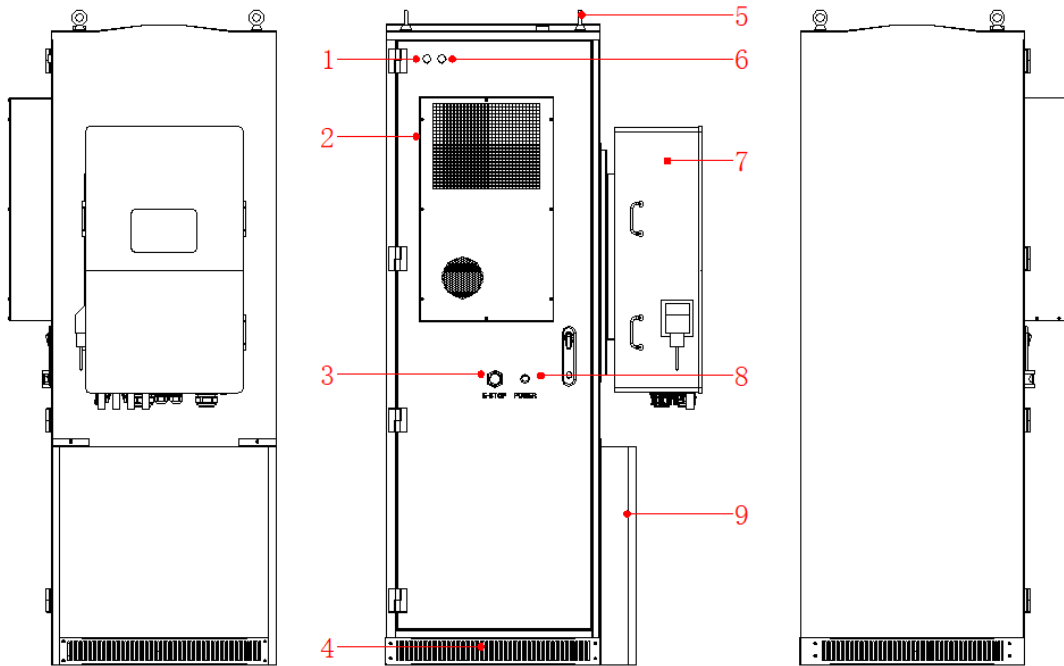

Figure 2-2 System Appearance

- (1) Operation indicator light    (2) Air conditioning    (3) Emergency stop button    (4) Base  
 (5) Lifting ring    (6) Alarm indicator    (7) PCS (optional)    (8) On/Off button    (9) Wiring  
 cover plate (optional)

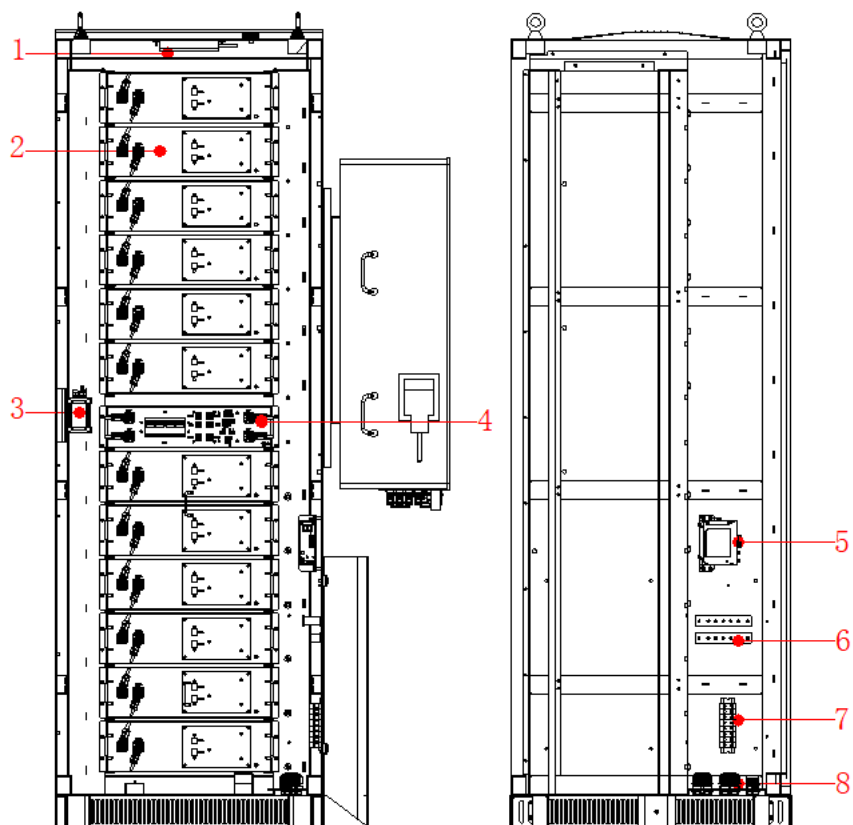

Figure 2-3 System composition diagram

- (1) Smoke sensor    (2) Battery module    (3) Fire protection module    (4) Main control module  
 (5) Data module    (6) Positive and negative copper bars    (7) terminal blocks    (8) outlet holes

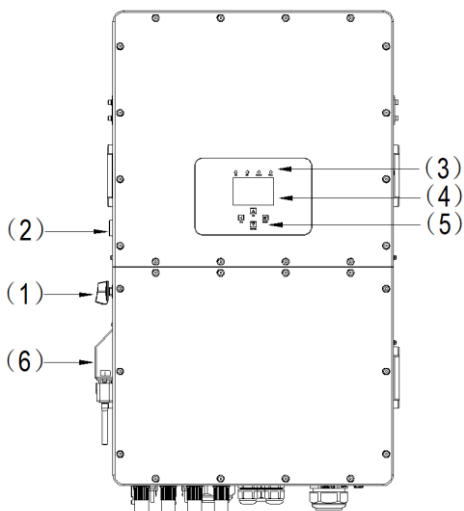

Figure 2-4 Inverter Appearance

**\*Note: Please refer to the actual product**

- (1) DC Switch    (2) Power on/off button    (3) Inverter Indicators    (4) LCD display  
 (5) Function Buttons    (6) Wi-Fi Interface

### 2.2.2 Battery modules Introduction

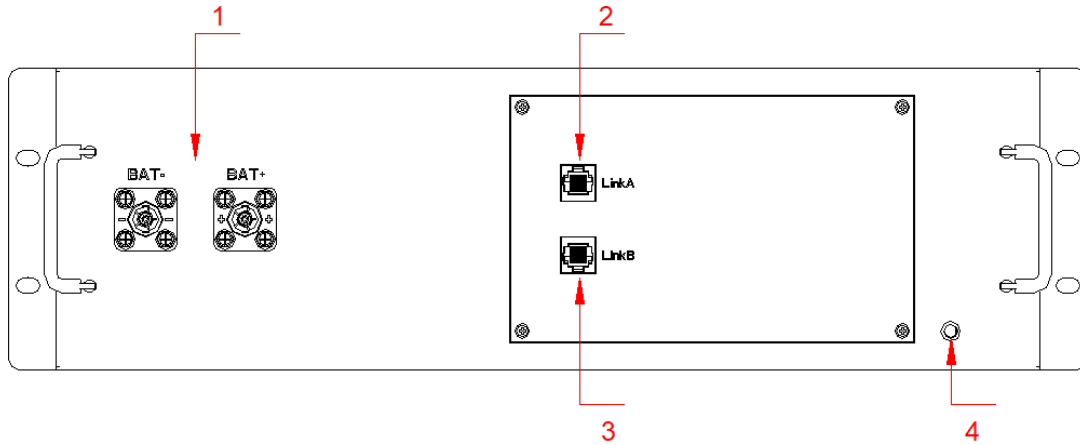

Figure 2-5 Appearance diagram of battery module

- (1) Positive and negative terminal      (2) Link A      (3) Link B      (4) Ground

Order	Definition	illustration
1	Positive and negative terminal	Battery positive and negative output terminals
2	Link A	Daisy Chain 1 Communication Port
3	Link B	Daisy Chain 2 Communication Port
4	grounding	Grounding protection point

### 2.2.3 Main control module introduction

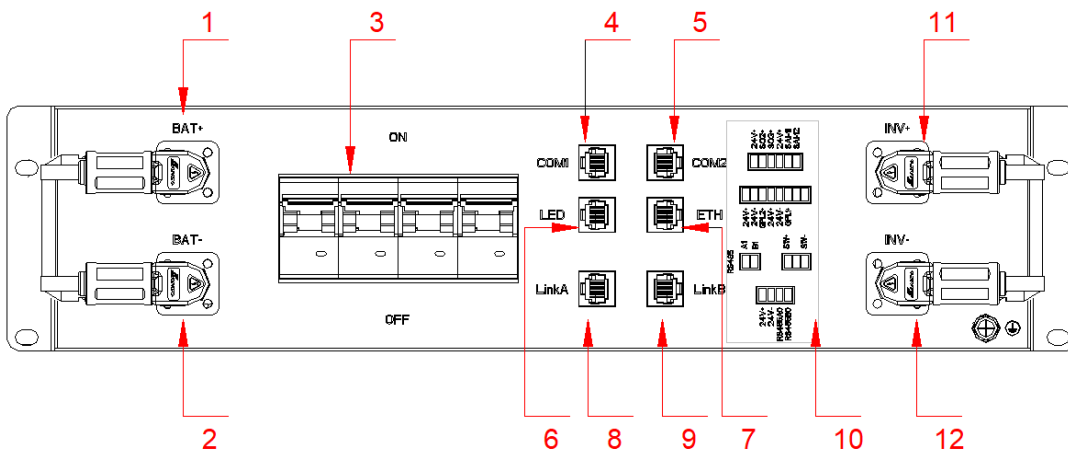

Figure 2-6 Appearance diagram of the main control module

- (1) BAT+    (2) BAT-    (3) air switch    (4) COM1    (5) COM2    (6) LED  
 (7) ETH    (8) Link A    (9) Link B    (10) functional interface    (11) INV+  
 (12) INV-    (13) grounding

Order	Definition	illustration
1	BAT+	Battery positive input terminal
2	BAT-	Battery negative input terminal
3	air switch	Isolation switch on/off DC main circuit
4	COM1	CAN communication line and parallel braided wire interface
5	COM2	CAN communication line and parallel braided wire interface
6	LED	Reserved LED light board wiring port
7	ETH	Ethernet interface
8	Link A	Daisy Chain 1 Communication Port
9	Link B	Daisy Chain 2 Communication Port
10	functional interface	24V output, power button interface, air conditioning communication interface, data module power supply and communication interface, emergency stop detection interface, access control detection interface, smoke detection interface
11	INV+	Connect PCS positive pole
12	INV-	Connect PCS negative pole
13	grounding	Grounding protection point

### 2.2.4 Nameplates Introduction

The following nameplate is for reference only, please refer to the actual product.

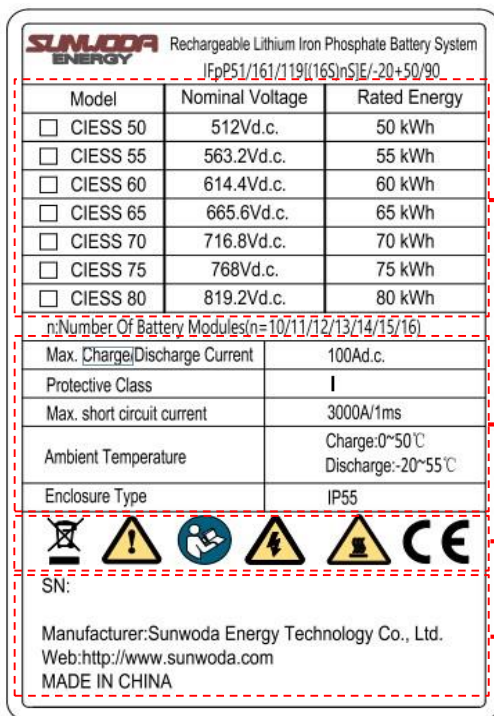

Product Name and Model

Product technical parameters

Product safety symbols and certification marks

Serial number and contact information

## 3 System Installation

### 3.1 Installation precautions



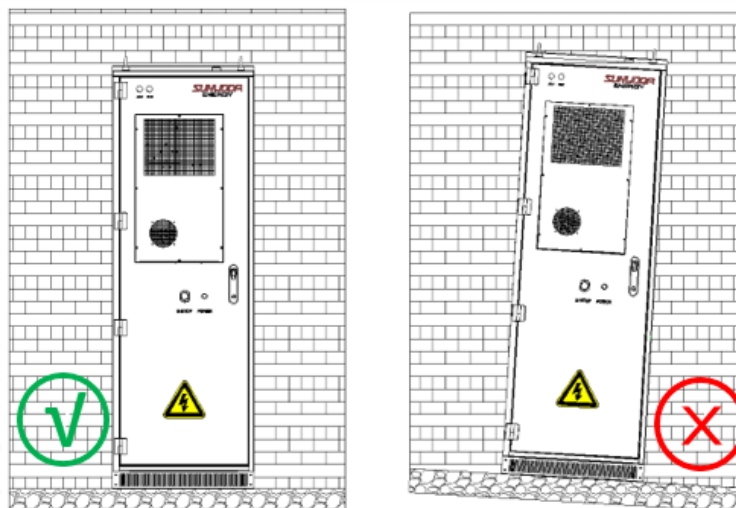

Before starting the installation, please follow the following instructions:





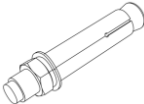
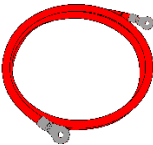

- Determine whether the ambient temperature at the installation site is within the specified range of -20 °C to +55 °C (recommended to be between 0 °C and 40 °C).
- The battery system needs to be installed on the ground with sufficient gravity and flatness. If the ground does not have sufficient support and flatness, it needs to be ensured through other means (such as making a foundation, adding load-bearing plates, etc.).
- Avoid installing near high-temperature heat sources or low-temperature cold sources.
- Avoid installing in areas with extreme changes in ambient temperature.
- Avoid installing in strong interference environments.
- Avoid installing in areas where children can come into contact.
- Avoid installing in areas prone to water accumulation.
- Please do not place flammable, explosive, or corrosive materials around the equipment.
- Please ensure that there is carbon dioxide, Novac1230, or FM-200 fire extinguishers near the equipment. When extinguishing a fire, please use a recommended material fire extinguisher, and do not use water or ABC dry powder fire extinguishers for extinguishing the fire; Firefighters must wear protective clothing and self-contained breathing apparatus.
- The installation location is well-ventilated and away from flammable and explosive materials. It is prohibited to install and operate in a salt spray environment.
- Before installation, the battery system needs to be transported to the installation location. To avoid personal injury or equipment damage during the transportation process, please pay attention to the following:
  1. Please equip corresponding personnel and tools according to the weight of the equipment to prevent it from exceeding the weight range that can be carried by the human body and injuring personnel.
  2. Please ensure that the equipment is balanced during transportation to avoid falling.
- The installation location of the product should be kept away from sunlight, rain, snow, etc. as much as possible.
- The product must not be tilted or placed on its side.



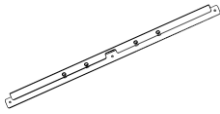

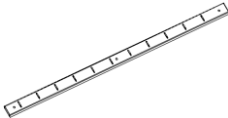
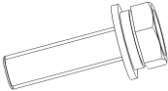
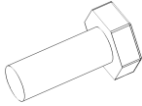
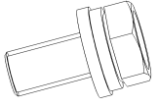
### 3.2 Pre installation inspection

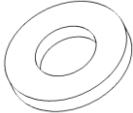
Before installation, please check whether the machine appearance is intact and whether the parts in the accessory package are consistent with the list.

NO.	Picture	Material Name	Specification Model	QTY.
1		Energy storage battery system	CIESS series energy storage battery system	1
2		Expansion bolt	M12X80 carbon steel coated with white zinc	4
3		PCS positive power line	10269, 6WA, 1.72M, red	2
4		PCS negative power line	10269, 6WA, 1.72M, black	2
5		Control box to PCS communication cable	2 meters of Category 5 network cable	1
6		Cable tie	YJ-120 2.5 * 120mm nylon white	30

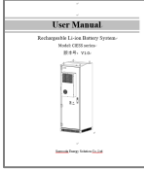
7		Cover Wire Board Assembly		1
8		PCS_ Bracket		2
9		Shroud-1		2
10		Shroud-2		2
11		Cable tie board		2
12		Stainless steel combination screw M4 * 16		8
13		Hexagonal head bolt M10 * 25		4
14		M6 * 14 cross recessed hexagonal head bolt, spring washer and plain washer assembly		30
15		Spring pad M10		4
16		Flat washer M10		4
17		General Certificate of Conformity	General Certificate of Conformity	1

18		User's manual	English	1
19		Desiccant	20g	4

### 3.3 Installation

#### 3.3.1 Installation preparation

The cabinet is installed on the ground and against the wall, with a base height greater than 200mm. Maintain good ventilation on both sides, and the minimum gap between both sides and the top should not be less than Figure 3-1. When installing PCS on the right side of the cabinet, the gap should be greater than 1000mm.

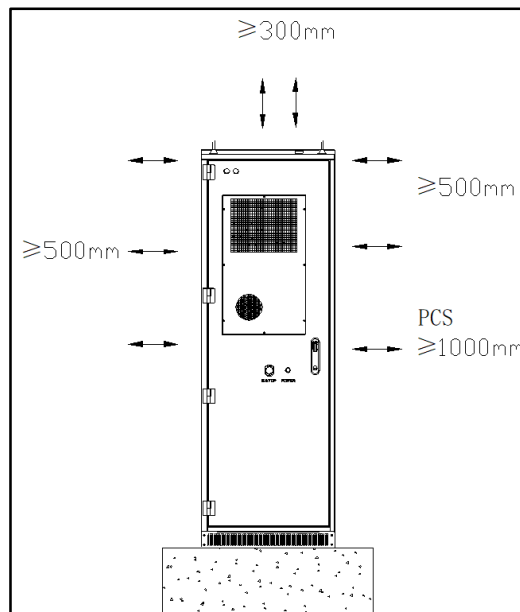

Figure 3-1 Installation diagram

#### 3.3.2 Installation guidance

**Step 1:** Floor-mounted installation of the cabinet, using expansion bolts to secure the cabinet to the base, with a base bearing capacity of >2000 Kg.

The size of the base opening is shown in Figure 3-2:



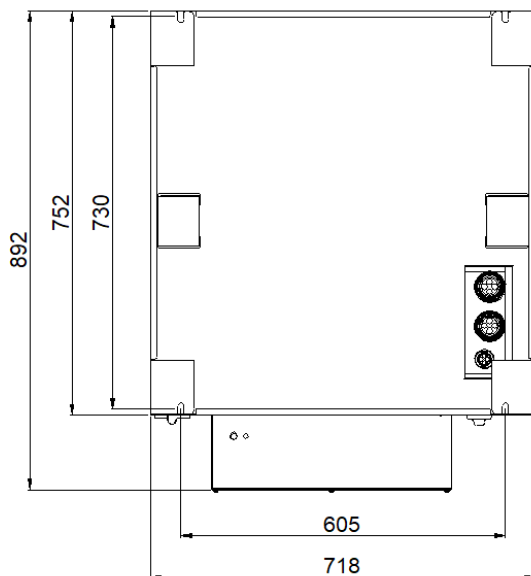

Figure 3-2 Cabinet Base Hole Size Diagram

**Step 2:** According to the size diagram of the base opening, use an impact drill to drill holes at the opening position. The diameter of the hole is 14mm, and the depth is about 80mm. Tap the expansion bolt into the hole.

**Step 3:** Use a forklift to move the cabinet, align the holes on the cabinet with the base bolts, fix the nuts of the expansion bolts, install the front and rear cover plates of the base, and complete the fixed installation of the cabinet.

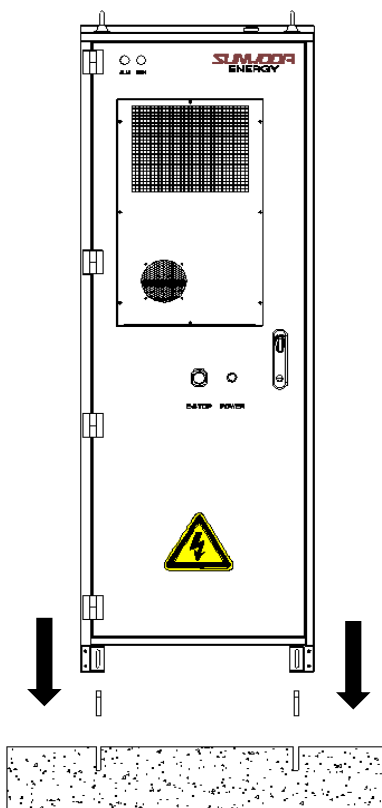

Figure 3-3 Schematic diagram of cabinet installation and placement

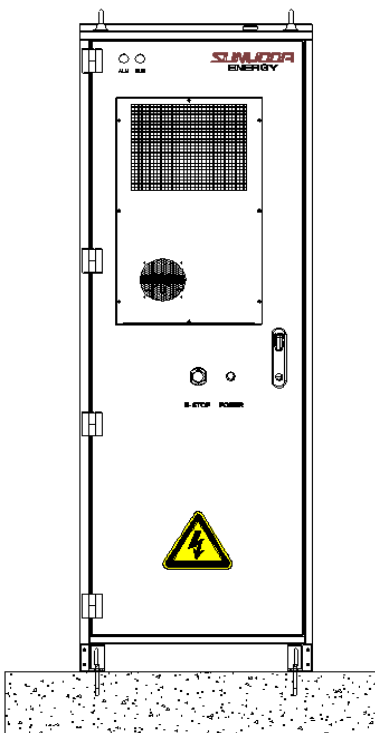

Figure 3-4 Schematic diagram of cabinet installation completion

**Step 4:** Install the inverter bracket and cable tie board bracket, install the inverter on the bracket and fix it.

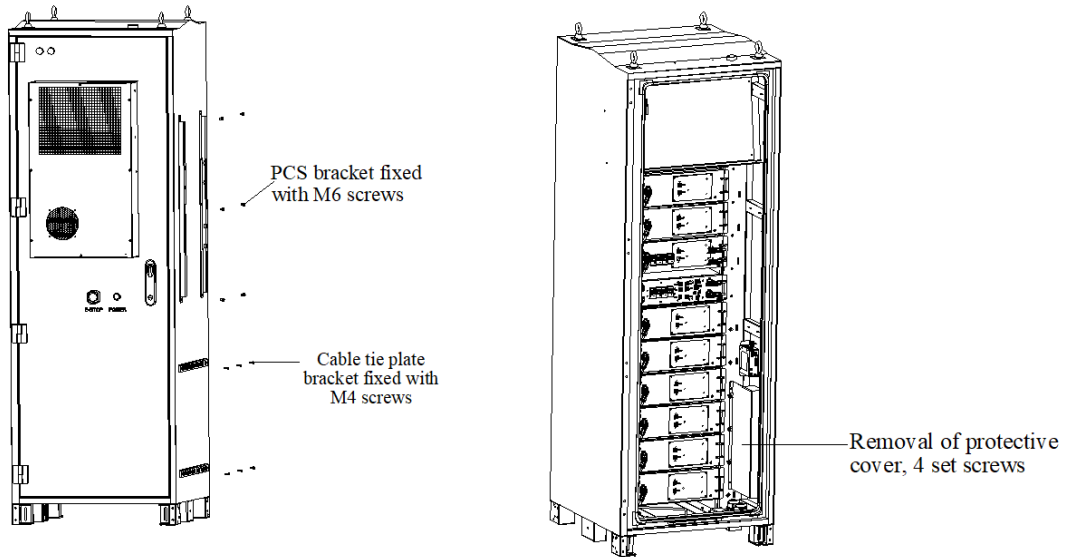

Figure 3-5 Installation diagram of inverter

**Step 5:** After the electrical cables are connected, tie the wires to the cable tie board and fix them, then install the cable cover board component. Finally, install the cover plates around the base.

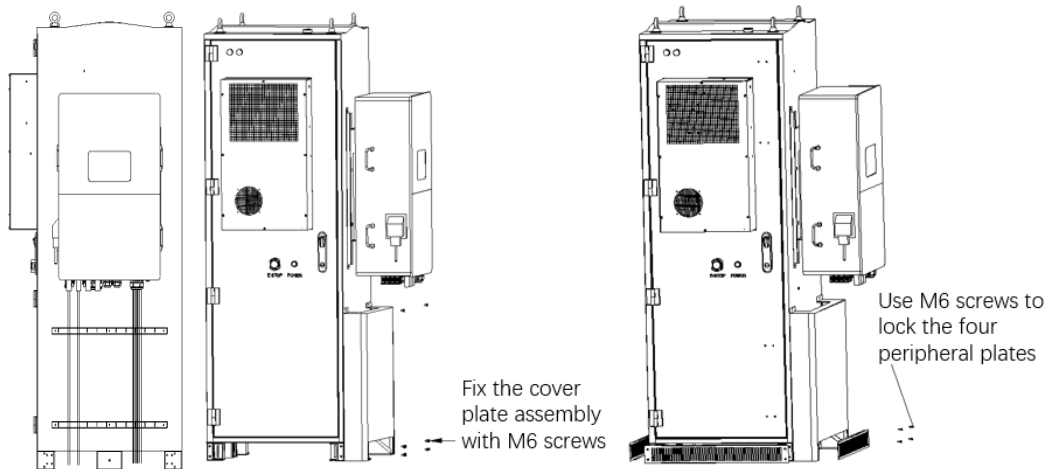

Figure 3-6 Installing the Base Cover Plate

### 3.4 Cable connection

Before connecting electrical cables, please ensure that all switches and higher-level switches on the main control box are disconnected. Using cables in high-temperature environments may cause aging and damage to the insulation layer, and the distance between the cable and the periphery of the heating device or heat source area should be at least 30mm.

Before connecting the electrical cables, please check whether the cables between the battery modules are properly connected according to the following electrical connection diagram.

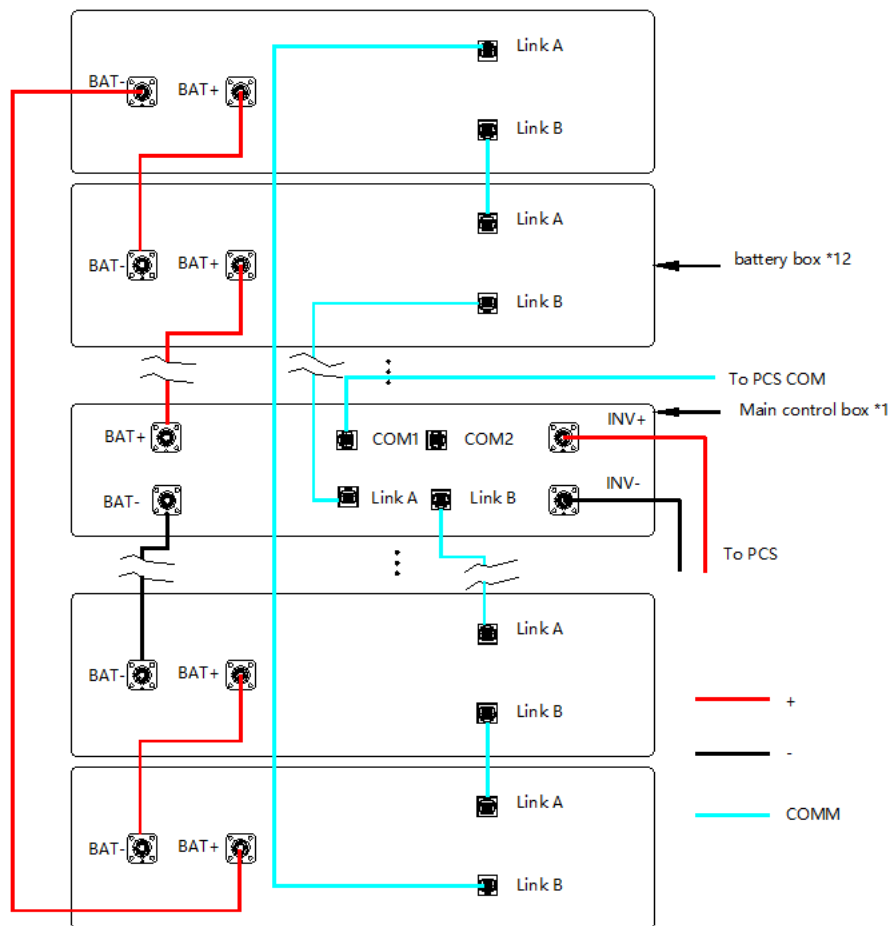

Figure 3-7 Battery Module Cable Connection Diagram

**⚠** When making electrical connections, the protective ground wire must be connected first; When dismantling equipment, the protective ground wire must be removed last.

### 3.4.1 Grounding

The grounding cable should be connected to the public grounding bar on the grid side to prevent electric shock. The recommended wire specifications for equipment grounding cables are as follows.

Model	Wire Size/Requirements	Cable(mm <sup>2</sup> )
CIESS series energy storage battery system	3AWG Yellow-green two-color cable M6Ring terminal	25

Connect one end of the grounding wire ring terminal to the grounding point on the top of the cabinet, and the other end to a common grounding point.

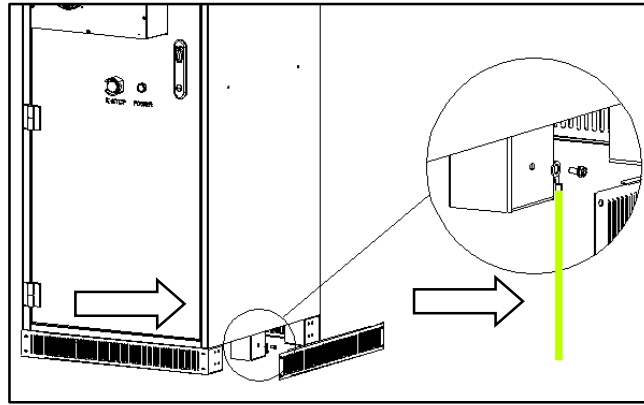

Figure 3-8 Cabinet Ground Wire Connection

### 3.4.2 AC cable connection

Please wire according to local electrical regulations and connect the external PE wires of the system together, as shown in Figure 3-9.

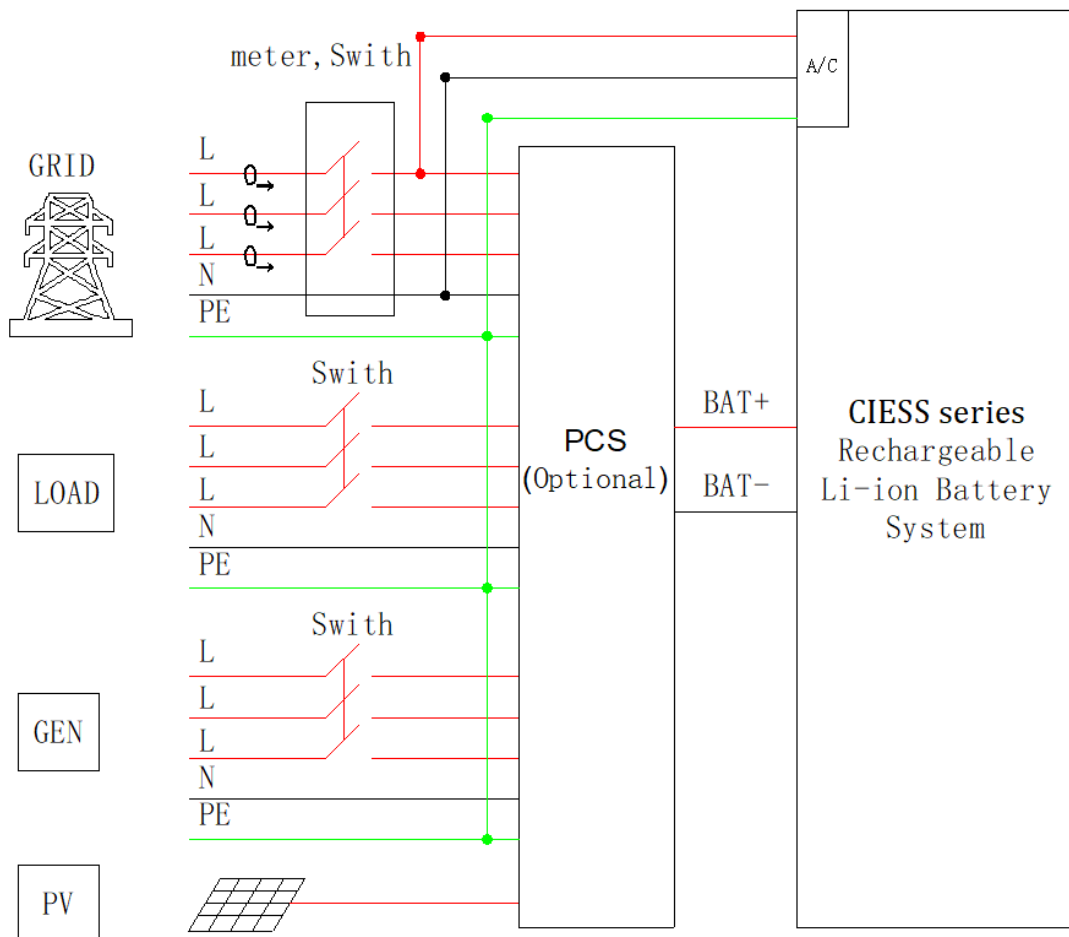



Figure 3-9 External Wiring Diagram

 Before making AC input/output connections, ensure that the AC power supply is disconnected and the battery is turned off.

The recommended wire specifications for AC input/output cables are as follows:

Model	Wire Size	Cable(mm <sup>2</sup> )
Inverter AC cable	1AWG	50
CISS outdoor cabinet air	14AWG	2.5

Please follow these steps to complete the air conditioning cable connection:

**Step 1:** After opening the door, use a stopper to limit it.

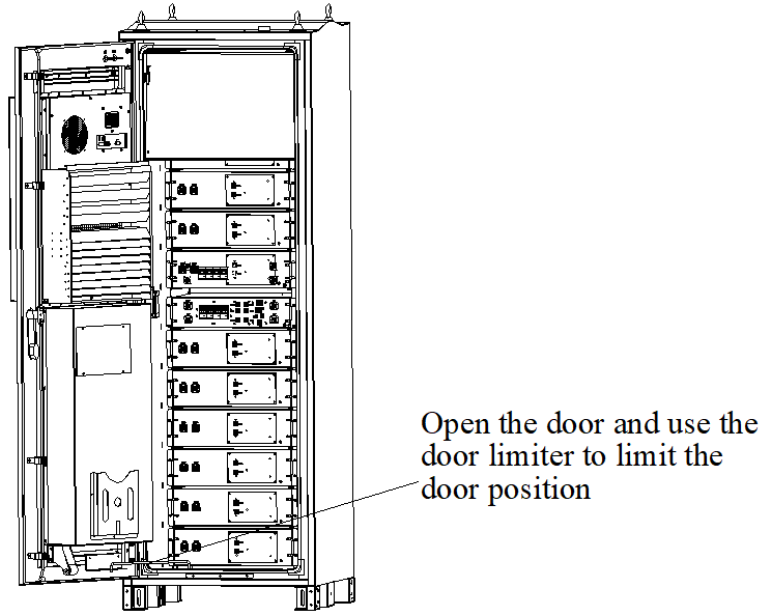

Figure 3-10 Door Opening Limit Bitmap

**Step 2:** Remove the protective cover plate

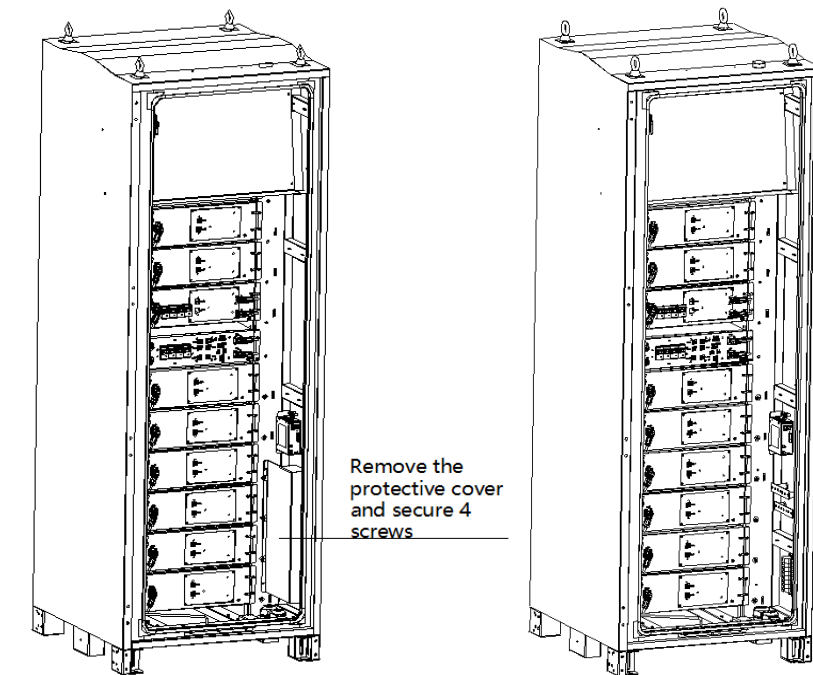

Figure 3-11 Protective Cover Plate

**Step 3:** Connect the air conditioning power supply line.

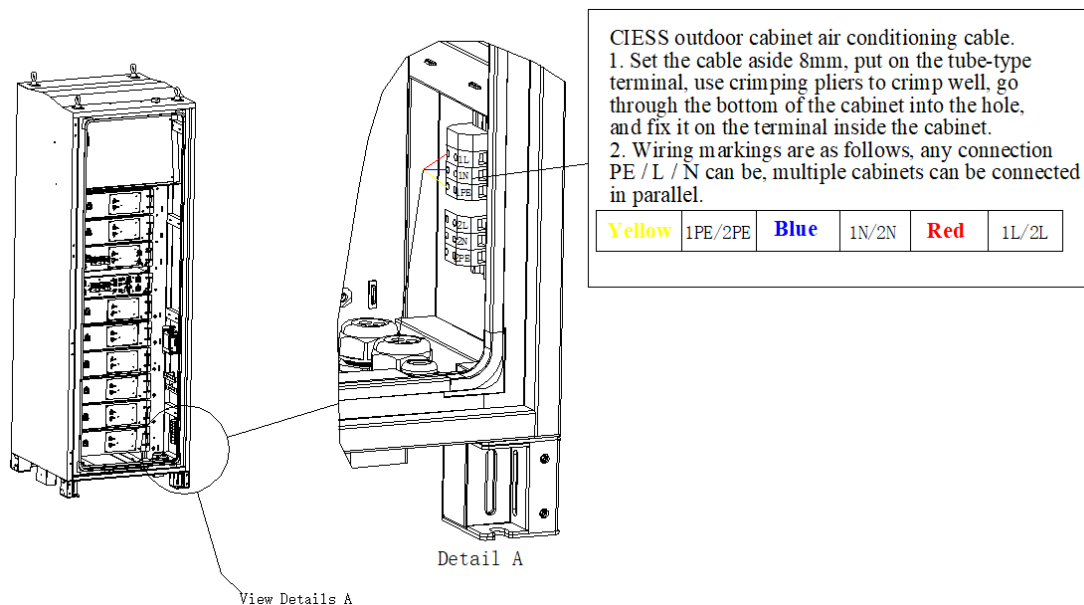

Figure 3-12 Schematic diagram of connecting air conditioning cables

### 3.4.3 DC cable connection

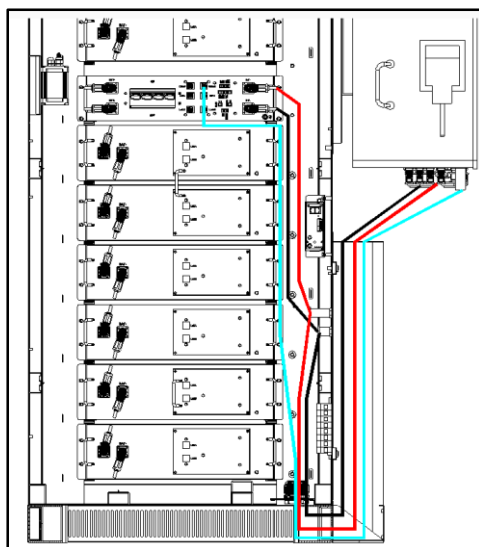

Figure 3-13 Schematic diagram of DC cable connection

**Step 1:** Connect the battery power line and ensure that the main control module switches are fully disconnected.

**Step 2:** The main control module INV+ and INV - are connected to the copper bars on the side of the cabinet, and the user uses the cabinet accessories to connect the cables. The red cable is fixed to the copper bar connected to the INV+, while the black cable is fixed to the copper bar connected to the INV -.

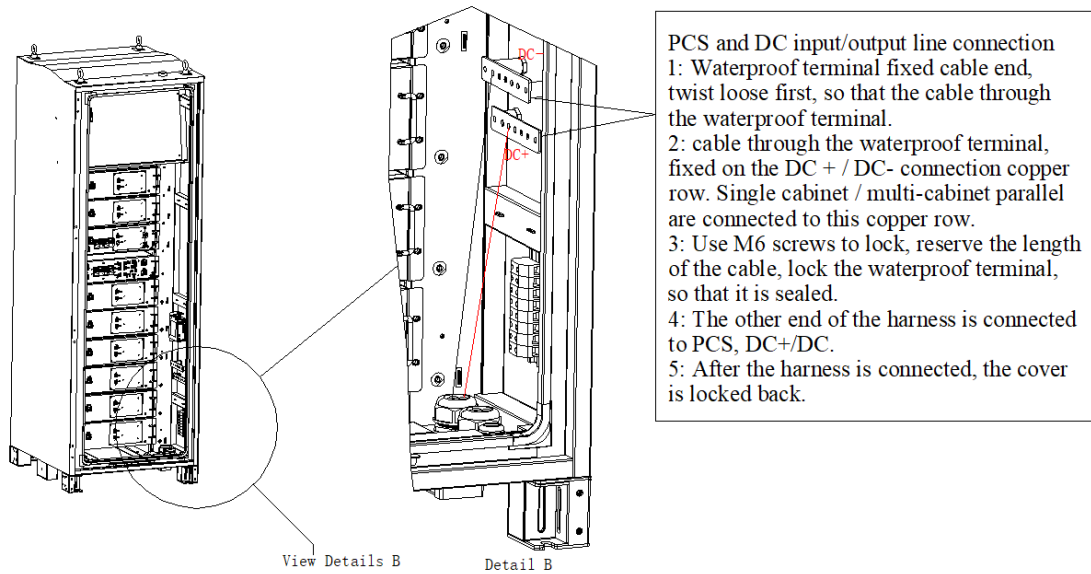

Figure 3-14 Schematic diagram of DC cable connection

**Step 3:** Pass the cable through the outlet hole at the bottom of the cabinet and connect it to B+ and B - of the inverter, respectively.

### 3.4.4 Communication connection

**Step 1:** Remove the communication cable from the attachment and connect one end to the COM1 interface of the main control box.

**Step 2:** The cable passes through the outlet hole at the bottom of the cabinet and is connected to the inverter COM, as shown in Figure 3-15.

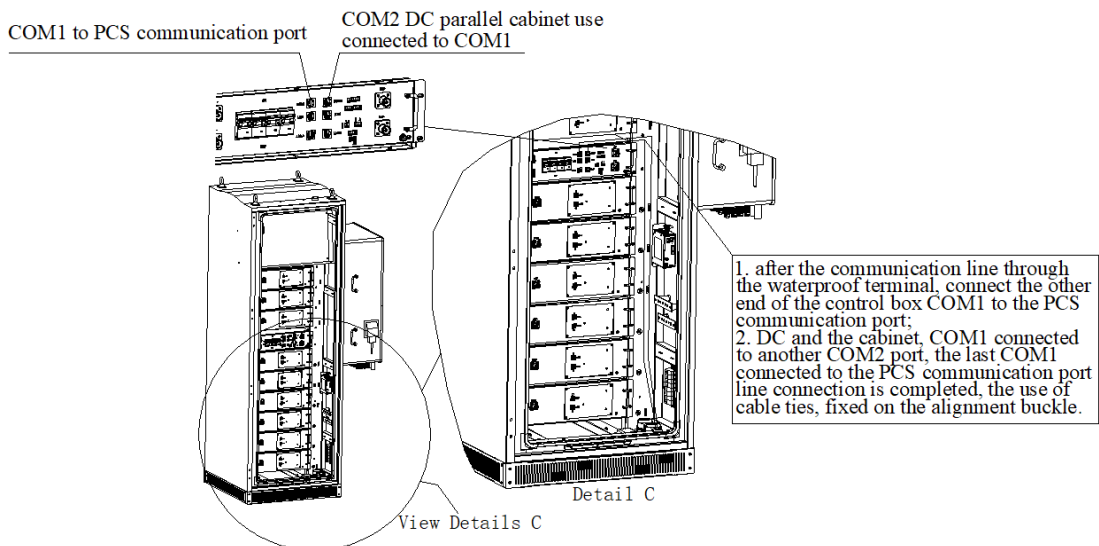

Figure 3-15 Communication Connection Diagram

## 4 Operating Instructions

### 4.1 Inspection before power on

(1) The equipment is firmly installed, the installation position is easy to operate and maintain, the installation space is convenient for ventilation and heat dissipation, and the installation environment

is clean and tidy.

(2) The protective grounding wire, battery power line, inverter power line, communication line, and AC line are connected correctly and firmly.

(3) The cable binding meets the routing requirements, is reasonably distributed, and is undamaged.

(4) Before powering up, all switches are off.

## 4.2 System startup

**Step1:** Open the front door, follow the direction indicated by the arrow in the figure below, and place the main control box air switch in the open state.

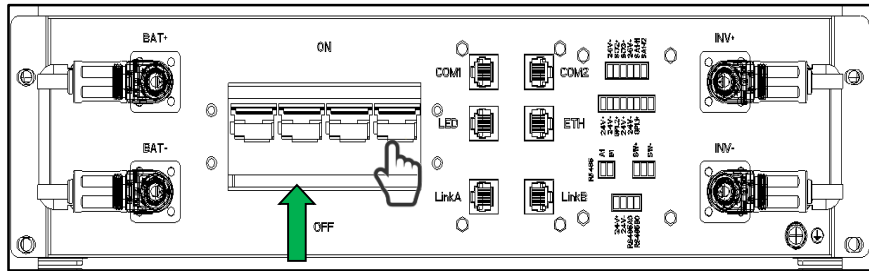

**Step2:** Press the POWER button on the front door for 3 seconds, and the green running indicator light will steadily flash at 1 Hz, and the battery will turn on.

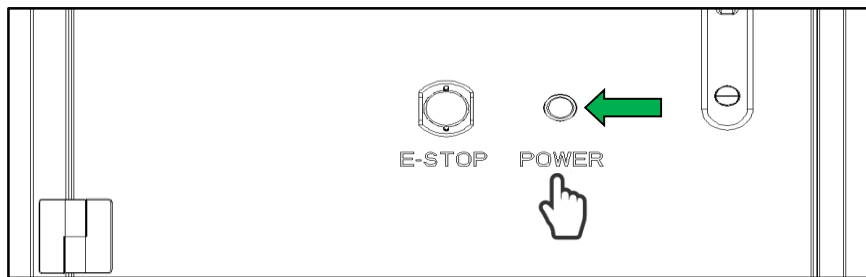

**Step3:** After the green indicator light on the cabinet door remains on, press the inverter ON/OFF switch, and the inverter LCD screen will light up to complete the inverter startup.

**Step4:** Set the inverter DC switch to "ON".

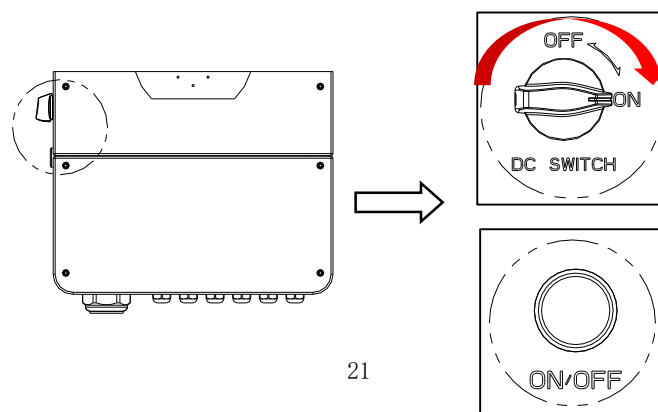



### 4.3 Indicator lights introduction

Order	red light	green light	illustrate
1	●	★	Initialization state, starting state, stopping state
2	●	●	running state
3	●	●	fault conditions

- Indicator light constantly off      ★The green light flashes at 1Hz      ●Red light always on
- Green light always on

## 4.4 System monitoring settings

Recommend using Google Chrome browser, version 113.0.5672.93 (official version) or higher (64 bit), PC system version Windows 10.

### 4.4.1 Local data monitoring

#### 4.4.1.1 Data module distribution network

(1) Use the following steps to change the IP address of the computer PC to obtain it automatically.

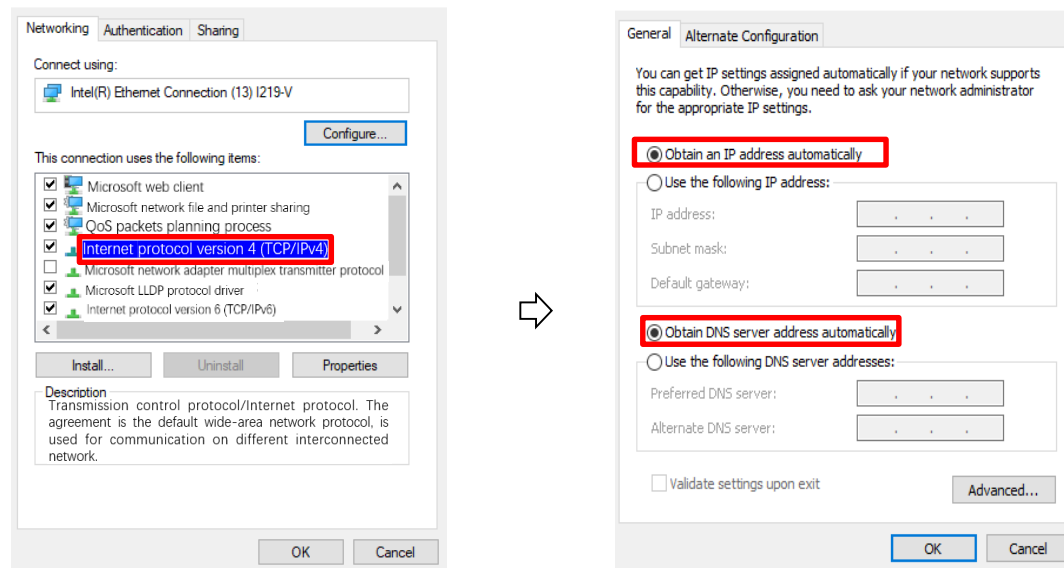
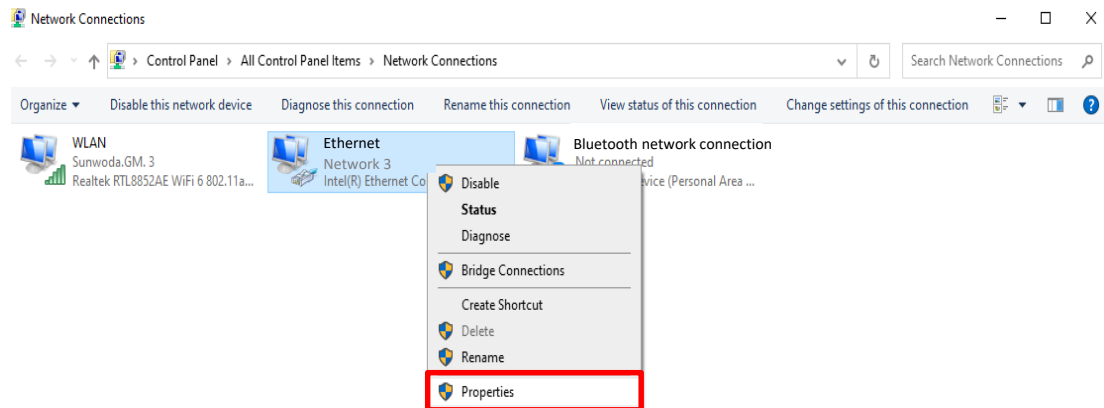

(2) Connect the data module LAN port to the PC network port through the RJ45 network port connector (8P), open the Google Chrome browser, and enter the website address 192.168.5.5, Account: user, Password: password.

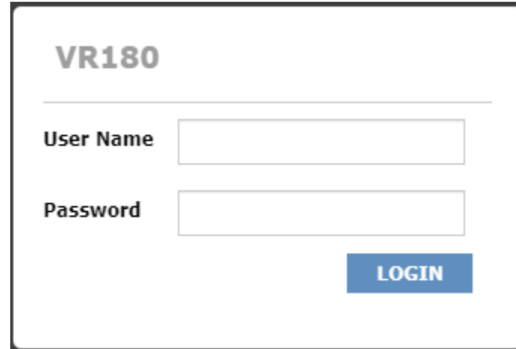
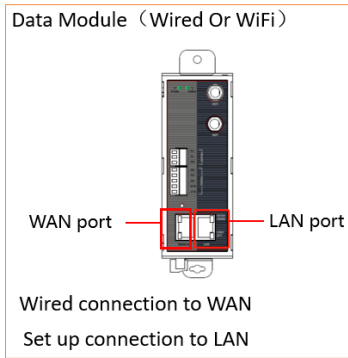

(3) Set the network access method and master-slave status of the battery cabinet on the current page. After setting, if there is a prompt to restart the device, please be patient.

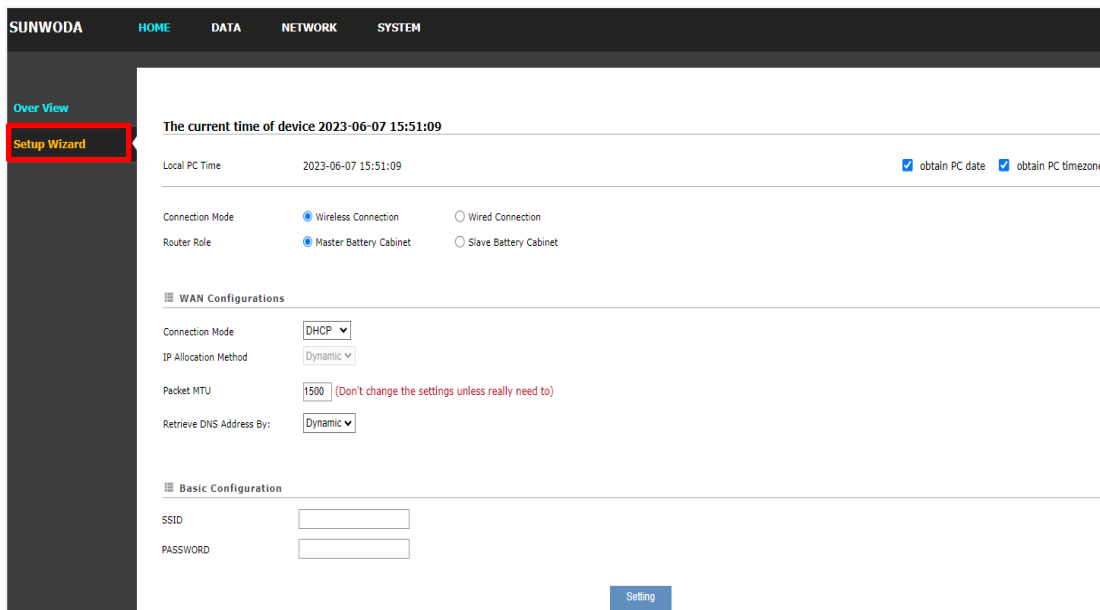

Item	Description
Router current time	Display the current router time
Local time	Display the current connected PC time
Obtain computer time	After checking, set the router's time and time zone to match the current connected PC
Obtain computer time zone	
<b>Connection method</b>	Refers to the connection method between routers Options: wireless connection, wired connection
Wireless	
Wired	
<b>Router Role</b>	Refers to the master-slave relationship of the connection during router networking Option: Master、Slave
Master	
Slave	
<b>Access method</b>	Set WAN access method
Dynamic IP address	The IP address will be assigned to the router through the Dynamic Host Configuration Protocol (DHCP)
Static IP address	Manually customizing IP addresses
<b>How to obtain an IP address</b>	Automatically match based on access method
Dynamic acquisition	Dynamically obtain IP address, mask, gateway information from the DHCP server
Manually specify	Manually specify relevant information such as IP address, mask, gateway, etc.
IP Address	Set the IP address for the router to access the WAN, format: XXXX
Mask	Set the router LAN port subnet mask, format: XXXX
Default gateway	Set the gateway address for the router to access the WAN, format:

	XXXX
Packet MTU	Set the Maximum transmission unit of the data packet. The default is 1500. Do not change it unless necessary
<b>Obtain DNS method</b>	Automatically match based on access method
Dynamic acquisition	Dynamically obtaining DNS from a DHCP server
Manually specify	Manually specify DNS, format: XXXX
Primary Name server	Set the IP address of the primary domain name server for router access to the WAN
From domain name server	Set the IP address of the domain name server for router access to the WAN
<b>Basic wireless configuration</b>	Configure when the networking connection method is wireless
SSID	The name of the wireless signal sent by the router
Secret key	Network key used to link wireless routers

**Note:**

- When using it for the first time, it is necessary to connect to the network and follow the prompts in the setup wizard to avoid missing the top and affecting normal use.
- When switching the role of the router between master and slave, in order to avoid the influence of the set parameters, please follow the setup wizard after the Factory reset.
- When the connection method is wireless, the SSID and key filled in by the Master and Slave roles must be consistent and within the coverage range of the wireless signal in order to connect normally.
- When the connection method is wired, it is necessary to confirm that the IP network segments of the Master and Slave roles cannot be the same. If there is a conflict, it needs to be modified.
- Format of IP address, subnet mask, DNS server, etc.: XXXX, please fill in according to the actual network environment to avoid affecting normal use.

4.4.1.2 Local Data Viewing

After configuring the network, log in to webpage 192.168.6.5, Account: user, Password: password. You can view site data and real-time data through the following pages:

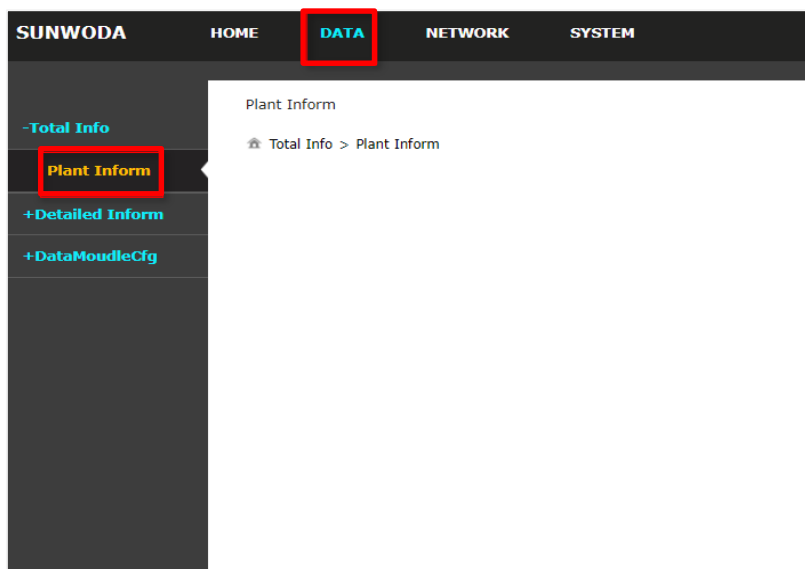

**Realtime Data**

Data Module > Realtime Data

Battery Cabinet Detail Info

Battery cluster master-slave status: Slave Cluster	Battery Packs Quantity: 6	Battery voltage Quantity: 96
Battery temperature Quantity: 48	Battery cabinet SN code: SUNWODA000000002	Control box SN code: SUNWODA1111222355
Data module SN code: VR18000223018001	Battery Cluster SOC: 48.0%	Battery Cluster SOH: 100.0%
Battery Cluster voltage: 317.6V	Total Cluster current: 0.0A	Rated power: 0.0KW
Rated Capacity: 100000mAH	Residual Capacity: 48000mAH	FCC: 100000mAH
Cycles: 0	Air Conditioner switch status: Turn OFF	Air Conditioner Operating status: Standby
Air Conditioner temperature value: 0°C	Air Conditioner alarm status: 0	Alarm external/internal 1/2: 0x0/0x8000/0x4000/0x0
Charging remaining time: 65535min	Discharge remaining time: 65535min	
Max single cell voltage/serial number: 3331mV/4	Min single cell voltage/serial number: 3296mV/48	
Max single cell temperature/serial number: 28°C/46	Min single cell temperature/serial number: 26°C/1	
Charging voltage limit: 650V	Charging current limit: 89.1A	
Discharge current limit: 104.8A	Cumulative charging energy: 48AH	
Cumulative discharging energy: 0AH	Battery cluster SIR Rp/Rn: 1000/1024	
Total voltage sampling value: 315.6V	External Alarm 1: 0x0	
External Alarm 2: 0x8000	Internal Alarm 1: 0x4000	
Internal Alarm 2: 0x0	External Fault 1: 0x0	
External Fault 2: 0x0	Internal Fault 1: 0x0	
Internal Fault 2: 0x0	Output IO status: 0x3	
Input IO status: 0x3	Cluster status: Running,Idle,Normal,Normal	
Cluster mode: Normal,Remote	BCMU hardware version: 2.0	
BCMU software version: 3.42		

#### 4.4.1.3 Local Data Download

You can download recording data, event recording, and real-time data through the following page.

**BMS Data**

BMS Data > DataDownload

Data Recording Wave

Data Record Download

Event Record Download

Event Record Download

Realtime Operational Data Record

Timing: 30:00

Data Content:  Feature Status Info  
 Other Info  
 Single Info

Start

#### 4.4.1.4 Local start stop control

BCMU start stop control can be carried out through the following page.

**System Switch**

Data Module > System Switch

BMS Working State: Running,Idle,Normal,Normal

BmsWorkStateControl: Start-up

Setting

## 4.4.2 Remote data monitoring

### 4.4.2.1 Account Registration

Login webpage <https://sunwoda.vidagrid.com/> Go to the following page, click and complete registration.

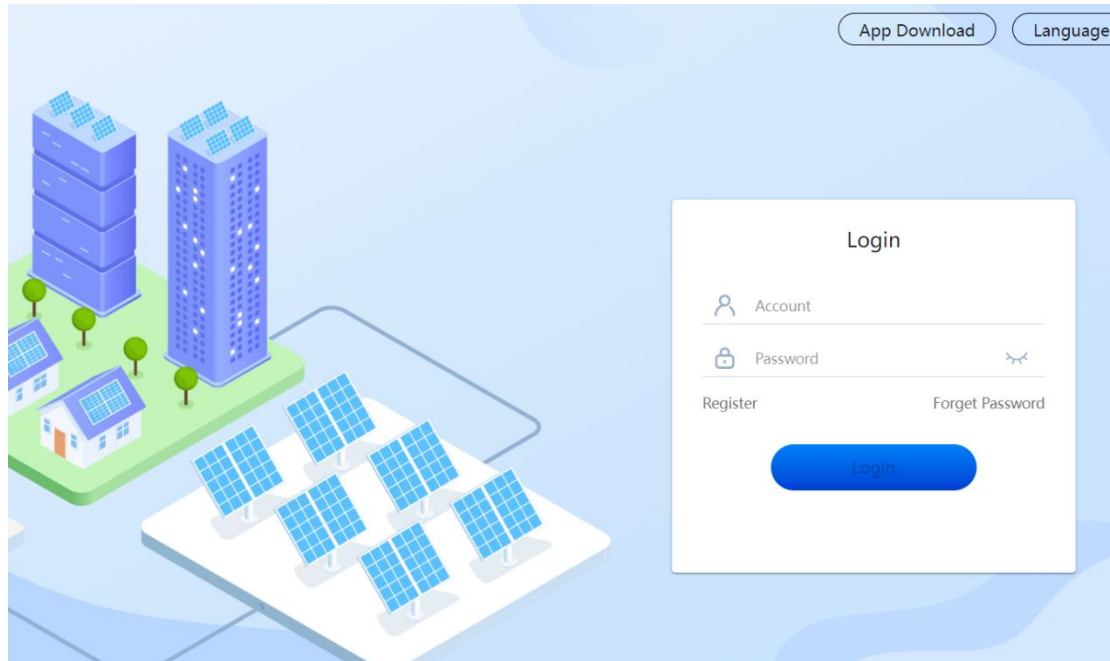

End User

Account\*

Username

Password\*

Confirm Password\*

Country/Area

Phone Number

E-mail\*

Verification Code\*

### 4.4.2.2 Adding Plants and Devices

Log in to the registered account, click on "Add plant" in the red box on the homepage, and complete the steps below to add the plant and device

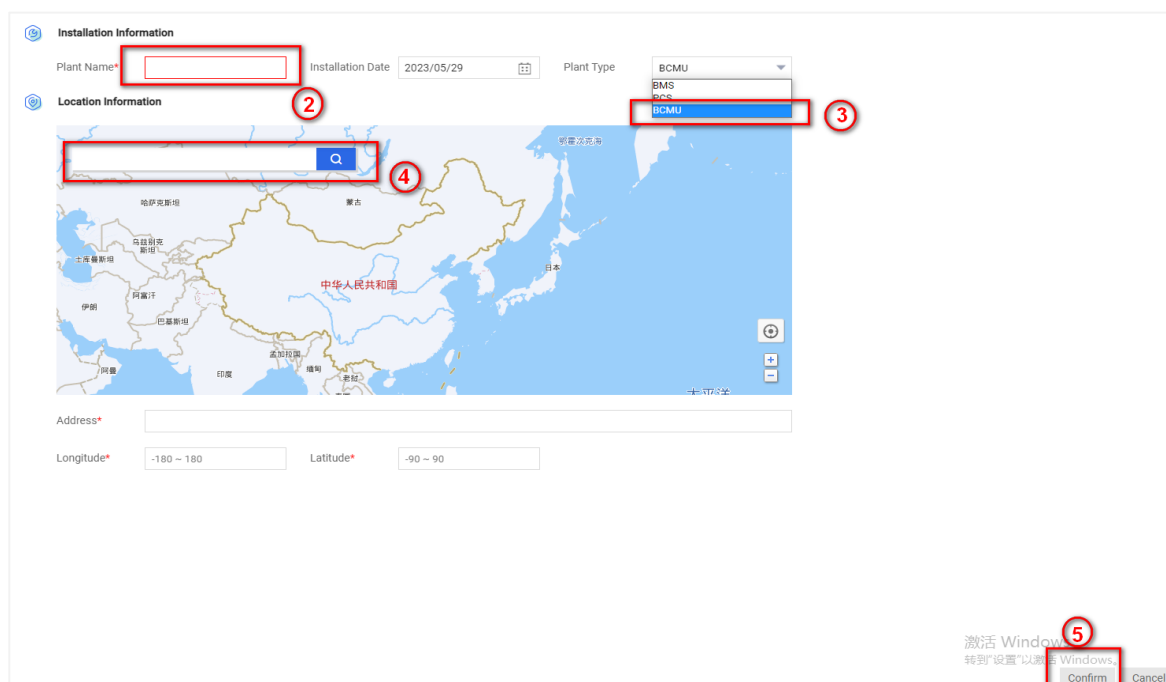
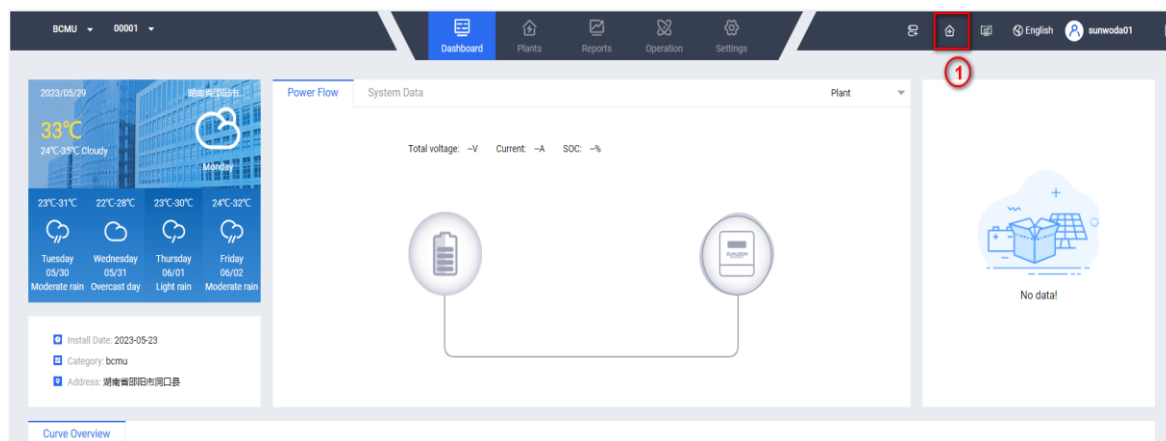

● Authorization Plant

Add device(Enter the Device SN which belong to the plant. It is not required. You can operate it again in Add Device which at th top.)

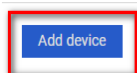

Authorization BCMU Engineer(Authorize the plant to the BCMU engineer, so that your BCMU engineer can help maintain the plant in the future. Tt is not required,you can operate it again in the Plant Management.)

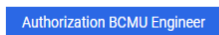

Authorization User(Authorize the plant to the user, so that the user can see the plant. It is not required, you can operate it again in the Plant Management.)

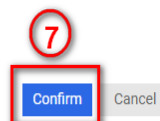
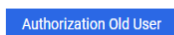

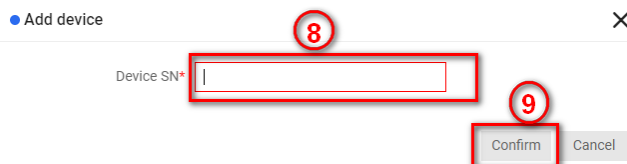

**Note:** SN code should be obtained from the battery nameplate on the cabinet information, which has 17 digits in length, remove the first character code and retain the last 16 digits as the valid, enter them here for binding, and make sure that the network configuration has been completed in advance (see 4.4.1.1 for more details).

#### 4.4.2.3 Remote data monitoring

(1) After adding the device, select the newly created plant and device in the current interface. You can refer to the location in the red box to view and export energy flow, system data, device details, and historical data.

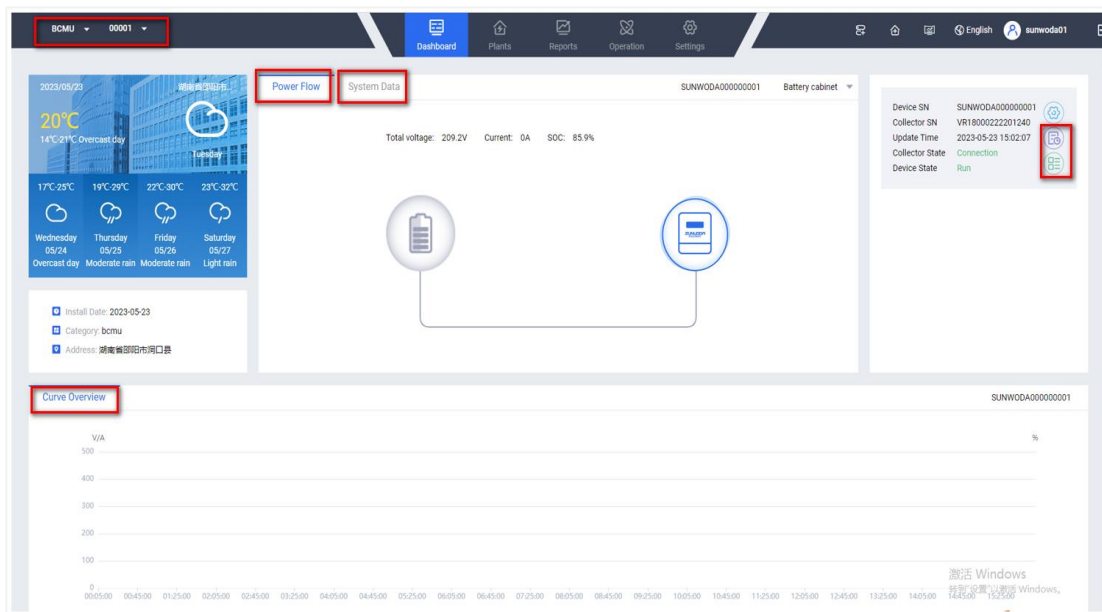

(2) You can refer to the location in the red box on the following page to view plant and device information.



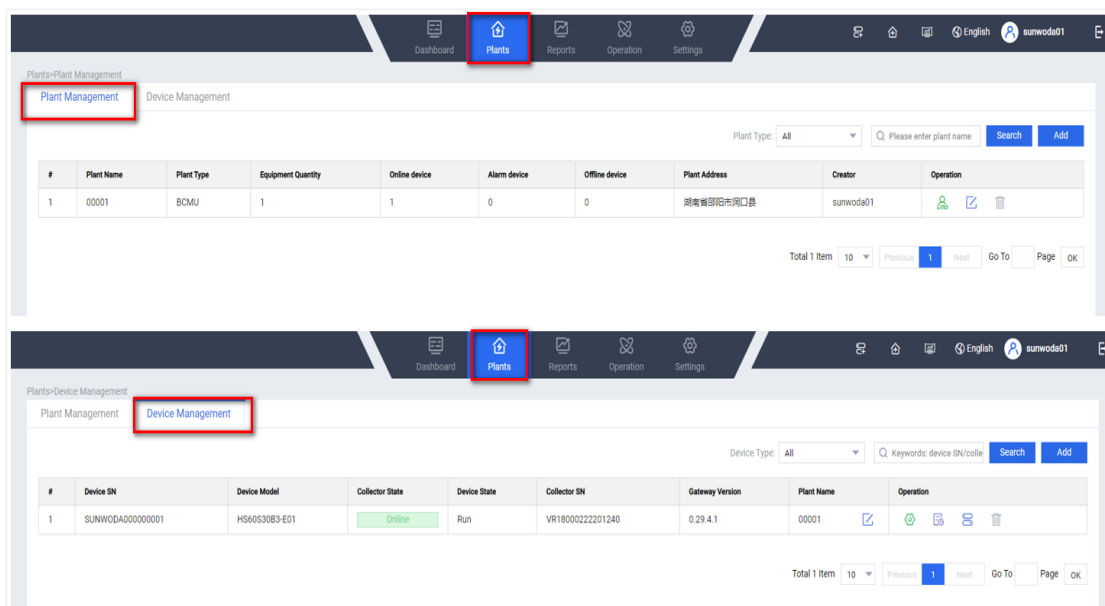

(3) You can refer to the position in the red box on the following page to view and export the energy and power reports of relevant plants and devices.

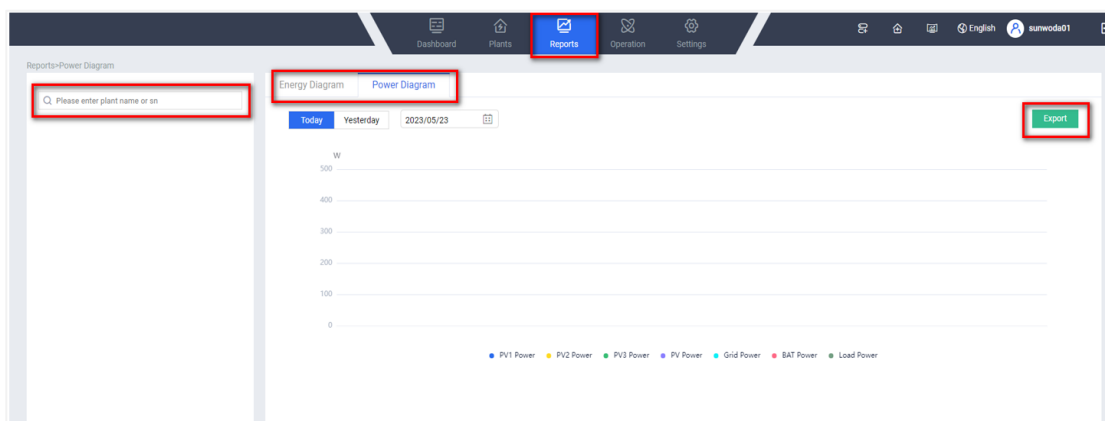

## 4.5 System Shutdown

Before powering down the battery system, please ensure that there is no load on the AC side of the inverter and that the circuit breaker between the battery system and the inverter is disconnected.

**Step 1:** Turn off the "LOAD" switch on the inverter side.

**Step 2:** Disconnect the "GRID" switch on the inverter side.

**Step 3:** Disconnect the "GNE" switch on the inverter side.

**Step 4:** Disconnect the air conditioning power supply switch.

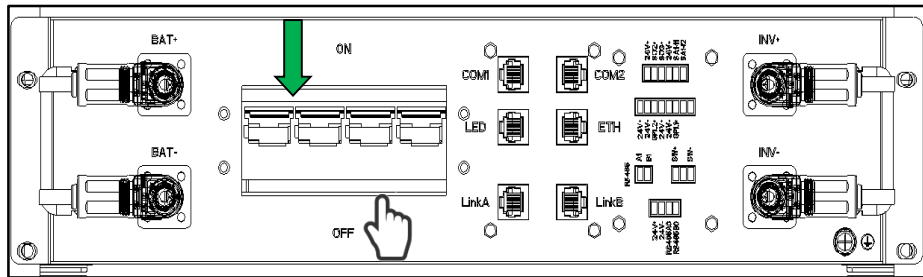
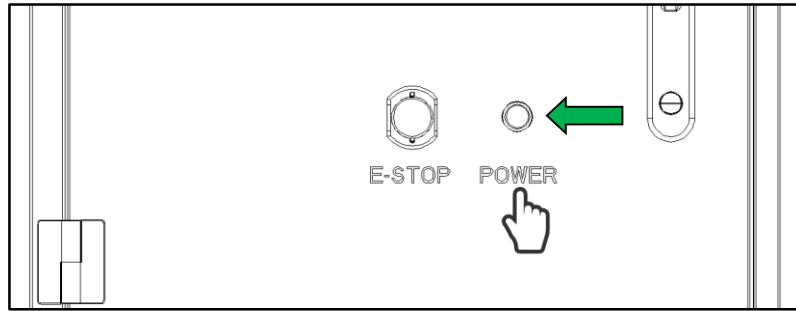

**Step 5:** Press the POWER button on the front door for 3 seconds; the running indicator light will turn off, the main control box air switch will be placed in a closed state, and the system will shut down.

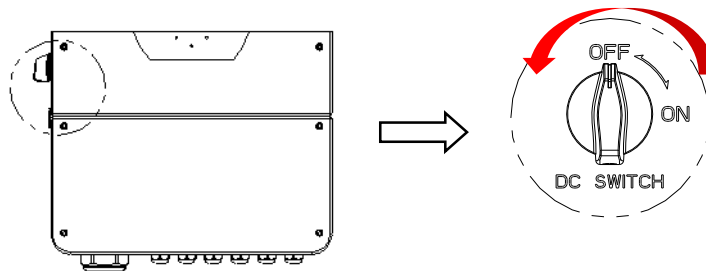

**Step 6:** Set the inverter DC switch to "OFF" and press the ON/OFF switch to complete the system shutdown.



## 5 Maintenance and Common Fault Handling

 <b>Dangerous</b>
<ul style="list-style-type: none"> <li>When operating and maintaining the battery system, please remove the power from the system. Operating the equipment with power may cause damage to the battery system or pose a risk of electric shock.</li> </ul>
 <b>Warning</b>
<ul style="list-style-type: none"> <li>If any issues are found that may affect the battery system or energy storage inverter system, please contact after-sales personnel, and unauthorized disassembly is prohibited.</li> </ul>
<ul style="list-style-type: none"> <li>If the copper wire inside the conductive wire is found to be exposed, do not touch it; and there is a danger of high voltage. Please contact after-sales personnel, and unauthorized disassembly is prohibited.</li> </ul>
<ul style="list-style-type: none"> <li>If other unexpected situations occur, please contact after-sales personnel as soon as possible and operate under their guidance, or wait for on-site operation by after-sales personnel.</li> </ul>

### 5.1 Daily maintenance

- It is recommended that the battery system needs to be recharged every 6 months from the factory.
- When the device is not in use for a long time, it is necessary to discharge the battery to a level between 45% and 55% and disconnect the battery output to avoid emptying the battery.
- During the storage period of the system, professional personnel should regularly inspect the system to check if the wiring is loose or detached, or clean the surface and interior of the system; If any defects are found, please contact the dealer promptly.

### 5.2 Battery Fault Handling





Fault phenomenon	Reason	Solution
The POWER button has no response	One click start wire damage or poor contact	Opening the side door and closing the POWER button on any battery can achieve one click power on for all battery packs.
		Please contact the supplier.
Short discharge time	Low battery level	Keep the product continuously charged for at least 2 hours to fully charge the energy storage battery system.
	Product overload	Check the load status and remove non critical loads.
	Battery aging, reduced capacity	To replace the battery, please contact the supplier to obtain the battery and its components

Unable to charge or discharge	Internal failure	Please contact the supplier
	Battery charging or discharging protection failure	Identify the corresponding fault cause based on the battery indicator light function status table;
	After the battery is discharged to the SOC protection value, it needs to be charged for a period of time before discharge is allowed	Charge the battery to the SOC value set for restart (default setting is 50%)
	Battery over temperature	Allow to stand at room temperature for more than 3 hours
Abnormal battery communication	Communication disconnection	Check if the CAN communication connection of the battery is secure.
Red light fault prompt appears	others	Based on the prompted fault information, check the indicator light function status table to identify the corresponding fault cause;
The inverter is powered on through the battery for the first time, and the battery reports discharge and short circuit protection	The parallel capacitance value of the input terminal on the battery side of the inverter is relatively high	Battery protection can be automatically restored
Inverter cannot start	Battery voltage too low or SOC below shutdown protection value	After starting the inverter through the power grid, charge the battery
The battery cannot be charged through the power grid	The Battery Setting interface does not select "grid charging allowed" or the Time of Use setting interface does not select "grid charging allowed"	Check if the Grid Charge of the Battery Setting in the LCD screen is enabled. Check if the Time of Use Grid Charge of the System Work Mode in the LCD screen is enabled.

	Battery failure protection	Based on the prompted fault information, check the indicator light function status table to identify the corresponding fault cause;
	Abnormal power grid	Check if the grid voltage is normal



## 6 Transportation and Storage

### 6.1 Transportation requirements

 <b>Dangerous</b>
<ul style="list-style-type: none"> <li>● Rough loading and unloading, severe vibration, impact, or compression are prohibited to prevent exposure to sunlight and rain; otherwise, it may cause battery short circuit, damage (leakage, rupture, etc.), fire or explosion, etc.</li> </ul>
 <b>Warning</b>
<ul style="list-style-type: none"> <li>● Please ensure that the equipment is balanced during transportation to avoid falling.</li> <li>● It is prohibited to carry the battery through its terminals, bolts, or cables during transportation to avoid damage to the battery.</li> <li>● When handling, the battery should be carried in the required direction, and it is prohibited to invert, tilt, fall, mechanical impact, rain or snow, or fall into the water.</li> </ul>
 <b>Attention</b>
<ul style="list-style-type: none"> <li>● The battery has passed UN38.3 certification, and this product belongs to Class 9 dangerous goods.</li> <li>● Comply with international regulations for the transportation of dangerous goods and meet the regulatory requirements of the transportation regulatory authorities of the country of origin, destination, and destination.</li> <li>● When transporting, it is recommended to choose sea freight or highways with good road conditions; and railway and air freight are not supported. During transportation, bumps and tilting should be minimized as much as possible.</li> <li>● Before transportation, the packaging of the battery must be checked for completeness and undamaged, and there must be no odor, leakage, smoke, fire, or other phenomena. Otherwise, transportation is prohibited.</li> <li>● When handling batteries, they should be handled with care; and it is strictly prohibited to touch the batteries, and personal safety should be taken into account.</li> <li>● The transportation packaging box must be firm, and care should be taken during loading, unloading, and transportation, with proper moisture-proof measures taken.</li> </ul>
 <b>Notice</b>

<ul style="list-style-type: none"> <li>● The handling of heavy objects must be balanced and stable with force; Move at a uniform and low speed. The positioning requirement is stable and slow to avoid any impact or drop that may scratch the surface of the equipment or damage the components and cables of the equipment.</li> </ul>
<ul style="list-style-type: none"> <li>● When carrying heavy objects, special attention should be paid to workbenches, slopes, stairs, and other areas that are prone to slipping. When carrying heavy objects through the threshold, ensure that the width of the door is sufficient for the equipment to pass through, to prevent collisions or scratches on fingers.</li> </ul>
<ul style="list-style-type: none"> <li>● When using a forklift for transportation, the forklift must be forked in the middle position to prevent tipping over. Before moving, please fasten the equipment to the forklift with ropes. When moving, a dedicated person is required to take care of it.</li> </ul>
<ul style="list-style-type: none"> <li>● The inclination angle of the cabinet should meet the requirements shown in the diagram, with a packaging inclination angle <math>\alpha \leq 15^\circ</math>, and inclination angle after removing packaging <math>\alpha \leq 10^\circ</math>.</li> </ul>
<ul style="list-style-type: none"> <li>● When handling equipment by hand, safety protective equipment such as protective gloves and safety shoes should be worn to avoid injury.</li> </ul>

## 6.2 Storage requirements

 <b>Warning</b>
<ul style="list-style-type: none"> <li>● The battery is stored indoors. No direct sunlight or rain, dry and well-ventilated, with a clean surrounding environment, free from a large amount of infrared and other radiation, no organic solvents or corrosive gases, no metal-conductive dust, etc., away from heat and ignition sources.</li> </ul>
<ul style="list-style-type: none"> <li>● If the battery experiences bulging, deformation, damage, or leakage, it must be scrapped regardless of storage time.</li> </ul>
<ul style="list-style-type: none"> <li>● When storing batteries, they should be placed correctly according to the packaging box markings. It is strictly prohibited to place them upside down, sideways, or tilted. When stacked, they should comply with the stacking requirements on the outer packaging.</li> </ul>
<ul style="list-style-type: none"> <li>● The site must be equipped with fire protection facilities that meet the requirements, such as fire sand, fire extinguishers, etc.</li> </ul>
 <b>Attention</b>
<ul style="list-style-type: none"> <li>● It is recommended to use batteries in a timely manner. For batteries that have been stored for a long time, please regularly recharge them; otherwise, it may cause battery damage.</li> </ul>
<ul style="list-style-type: none"> <li>● The ambient air should not contain corrosive or flammable gases and should not be tilted or stored upside down.</li> </ul>
 <b>Notice</b>

<ul style="list-style-type: none"> <li>● During storage, relevant certificates that meet the storage requirements of the product need to be saved, such as temperature and humidity log data, storage environment photos, and inspection reports.</li> </ul>
<ul style="list-style-type: none"> <li>● Store in a clean and dry place and prevent erosion by dust and moisture. It is prohibited to suffer from rainwater or surface water erosion.</li> </ul>
<ul style="list-style-type: none"> <li>● Storage environment requirements:  Recommended storage temperature: 20 °C~30 °C.  Relative humidity: 5% RH to 80% RH.  Dry, ventilated, and clean. Avoid contact with corrosive organic solvents, gases, and other substances.  Avoid direct sunlight. The distance from the heat source must not be less than two meters.</li> </ul>
<ul style="list-style-type: none"> <li>● From the date of shipment by the manufacturer, the battery needs to be maintained at a maximum interval of 6 months. The requirements for the recharge interval after the battery is emptied are as follows:  If the ambient temperature is (30,40] °C, power should be replenished within 15 days; if the ambient temperature is <math>\leq 30</math> °C, power should be replenished within 30 days.  It is recommended to store at a state of charge of 45% to 55% SOC.</li> </ul>

## Appendix: Technical Specification Parameter Table

Type	CISS 50	CISS 55	CISS 60	CISS 65	CISS 70	CISS 75	CISS 80
<b>System Parameter</b>							
Number of battery modules	10	11	12	13	14	15	16
Rated voltage	512V	563.2V	614.4V	665.6V	716.8V	768V	819.2V
Rated energy	50kWh	55kWh	60kWh	65kWh	70 kWh	75 kWh	80 kWh
Operating voltage range	448~576V	492.8~633.6V	537.6~691.2V	582.4~748.8V	627.2~806.4V	672~864V	716.8~921.6V
Weight	740kg	790kg	840kg	1000kg	1050kg	1100kg	1150kg
Dimensions (L * W * H)	715*750*2140mm			1300*750*1700mm			
Extend	Supports up to 3 cluster battery cabinets for parallel operation						
Protection grade	IP55						
Temperature control method	air-conditioning						
Charging ambient temperature	0°C~50°C						
Discharge ambient temperature	-20°C~55°C						
Working environment humidity	10%~95% RH (without condensation)						
Recommended storage temperature	20°C~30°C						
Communication	CAN/RS485						
Maximum continuous charging current	100A						
Maximum continuous discharge current	100A						
Maximum working altitude	2000m						
Cycle life	6000 times (25 °C, 0.5C/0.5C, 90% DOD, EOL 70%)						
Basic protection functions	Charging overvoltage, discharging under voltage, overcurrent, over temperature, short circuit protection, etc.						
Authentication	IEC62619/CE/UN38.3						
<b>Packaging, transportation, and installation</b>							
Package	Whole machine wooden box packaging						
Transport	Sea and land transportation						
Installation method	Hoisting and floor fixing						





[www.bpathenergy.com](http://www.bpathenergy.com)

Address: Thomas Edisonstraat 5, 3284WD Zuid-Beijerland, Netherlands

E-mail: [info@bpathenergy.nl](mailto:info@bpathenergy.nl) Tel: +31624925649

**SUNWODA**  
ENERGY

**[www.sunwodaenergy.com](http://www.sunwodaenergy.com)**

Address: No.18,Tangjia South Road,FengHuang Street, Guangming New District, Guangdong, China  
E-mail: [info@sunwoda.com](mailto:info@sunwoda.com) Tel: +86 755 2267 0380